

**Kit Frame**

Installation and usage instructions

EN

**Kit Frame**

Montage-und Gebrauchsanleitung

DE

**Kit Frame**

Instructions de montage et mode d'emploi

FR

**Kit Frame**

Instrucciones de montaje y uso

ES

**Kit Frame**

Istruzioni di montaggio e d'uso

IT

Please consult the website for  
instructions in the languages:  
NL-SV-DA-NO-FI-PT



# CARRY-BIKE









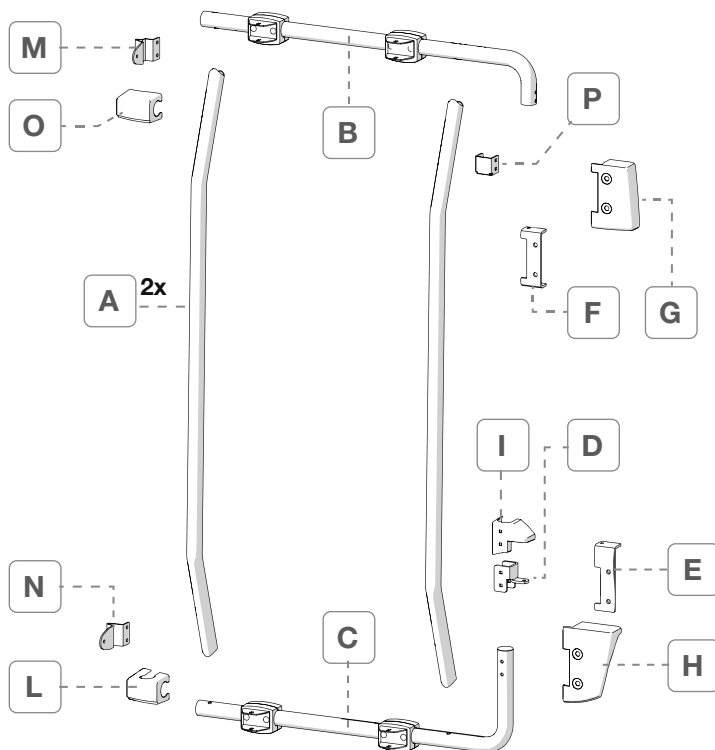











**KIT FRAME DUCATO**

**08753-01-**



**FIAT DUCATO**



- 
**Q** **M6x25**  
1x
- 
**R** **N/50/M6**  
1x
- 
**S** **M6**  
4x
- 
**T** **6,5x18x2**  
3x
- 
**U** **6,4x12,5x1,6**  
4x
- 
**V** **M6x25**  
2x
- 
**Z** **4x**
- 
**K** **M6x25**  
4x
- 
**J** **4x**
- 
**W** **8,4x20x2**  
4x
- 
**X** **4x**
- 
**A2** **8,4x17x1,6**  
4x
- 
**B2** **M8**  
4x
- 
**C2** **M6**  
1x
- 
**D2** **M8**  
4x
- 
**E2** **M6x18**  
1x
- 
**F2** **M6x55**  
2x
- 
**G2** **M6x50**  
2x
- 
**L2** **M6x45**  
4x
- 
**M2** **6,5x18x2**  
3x



Ø 6,5  
Ø 8

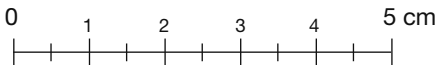
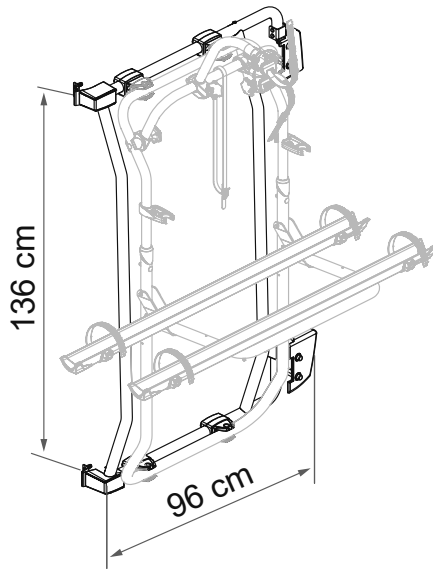

---

Package contents / Verpackungsinhalt / Contenu de l'emballage / Contenido del embalaje / Contenuto dell'imballo	<b>p. 2</b>
Installation instructions / Montageanleitung / Instructions de montage / Instrucciones de montaje / Istruzioni di montaggio	<b>p. 4</b>
Safety instructions / Sicherheitshinweise / Consignes de sécurité / Instrucciones de seguridad / Avvertenze di sicurezza	<b>p. 15</b>
Warranty / Garantie / Garantie / Garantía / Garanzia	<b>p. 16</b>



- EN** Check that nothing has been damaged or deformed during transport. In the event of doubts or questions concerning the installation, use or limitations of the product, contact the dealer. **We recommend that the installation is carried out by qualified personnel and in compliance with current local regulations.**
- DE** Bitte kontrollieren Sie, dass alle Einzelteile einwandfrei sind und nicht während dem Transport beschädigt wurden. Im Zweifelsfall oder bei Fragen zur Montage, Verwendung oder zu Einschränkungen des Produkts wenden Sie sich bitte an den Händler. **Wir empfehlen die Anbringung durch Fachpersonal in Übereinstimmung mit den geltenden lokalen Vorschriften vornehmen zu lassen.**
- FR** Contrôler le contenu du colis et vérifier qu'aucune pièce n'ait été cassée ou déformée durant le transport. En cas de doutes ou de questions relatives à l'installation, l'utilisation du produit, contactez le concessionnaire. **L'installation doit être réalisée par des personnes dûment qualifiées et conformément aux normes en vigueur dans le pays d'installation.**
- ES** Controlar que ningún detalle se haya roto o deformado durante el transporte. En caso de dudas o si tiene alguna pregunta sobre el montaje, uso y limitaciones del producto, póngase en contacto con el distribuidor. **Recomendamos que la instalación se realice por personal cualificado en conformidad con las regulaciones locales.**
- IT** Controllare che nessun particolare sia rotto o deformato a causa di errori di trasporto. In caso di dubbi o domande relative al montaggio, utilizzo e limiti del prodotto, contattare il rivenditore. **Consigliamo di far eseguire l'installazione da parte di personale qualificato ed in conformità alle vigenti normative locali.**



- EN** Installation only on right rear door
- DE** Installation nur an der rechten Tür
- FR** Installation seulement sur porte arrière droite

- ES** Instalación en portón derecho solamente
- IT** Installazione solo su portellone destro



- EN** Not suitable for vehicles with 270° hinge system
- DE** Nicht geeignet für Fahrzeuge mit 270° Scharniersystem
- FR** Ne convient pas aux véhicules équipés de charnières à 270°

- ES** No apto para vehículos con sistema de bisagras 270°
- IT** Non adatto ai veicoli con sistema di cerniere a 270°

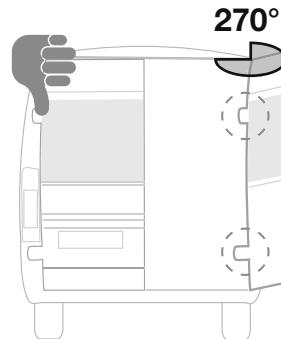
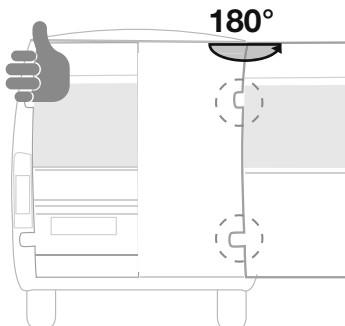



- EN** Before installation, make sure that the rear door is securely closed.
- DE** Vor der Montage sicherstellen, dass die Tür gut geschlossen ist.
- FR** Avant de procéder au montage, vérifier que la porte soit bien fermée.

- ES** Antes del montaje es preciso asegurarse de que el portón esté bien cerrado.
- IT** Prima del montaggio, assicurarsi che il portellone sia ben chiuso.

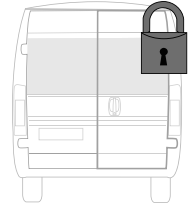
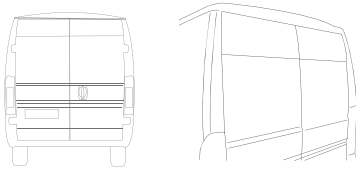
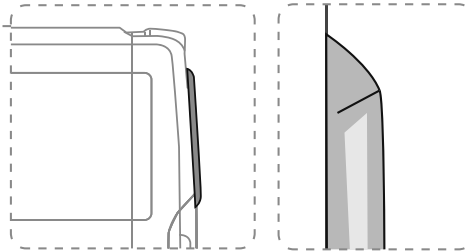
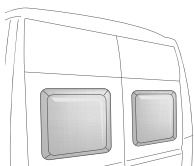
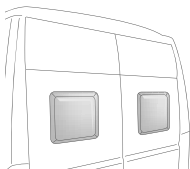
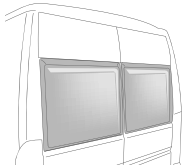
**Standard original vehicles (not modified)****Camper vans with a rear windows****REAR WINDOWS**

- EN** To check the compatibility of the Ducato Carry-Bike Frame with the windows of your vehicle, download the template from our website [fiamma.com](http://fiamma.com) and follow the instructions.
- DE** Um die Kompatibilität des Ducato Carry-Bike Frame mit den Scheiben eines Fahrzeugs zu überprüfen, die Vorlage von unserer Website [fiamma.com](http://fiamma.com) herunterladen und den Anweisungen folgen.
- FR** Pour vérifier si votre Carry-Bike Frame Ducato est compatible avec une installation sur les fenêtres de votre véhicule, téléchargez sur notre site [fiamma.com](http://fiamma.com) le gabarit et suivez les instructions.
- ES** Para verificar la compatibilidad del Carry-Bike Frame Ducato con las ventanas de su vehículo, descargue la plantilla en nuestro sitio [fiamma.com](http://fiamma.com) y siga las instrucciones.
- IT** Per verificare la compatibilità del Carry-Bike Frame Ducato con le finestre del tuo veicolo, scarica dal nostro sito [fiamma.com](http://fiamma.com) la dima e segui le istruzioni.



1

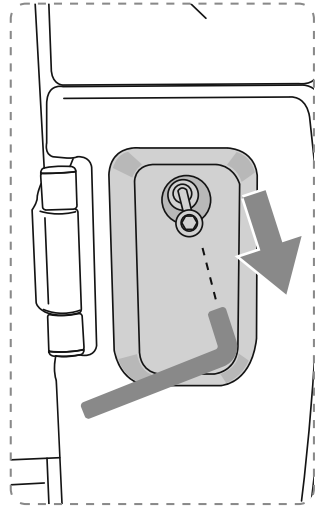
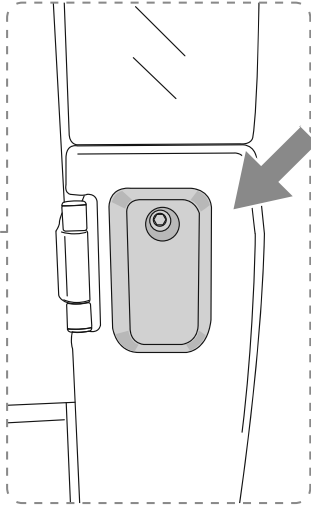
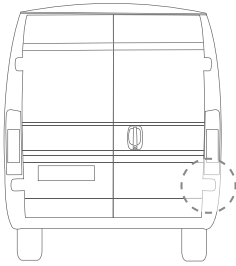

2

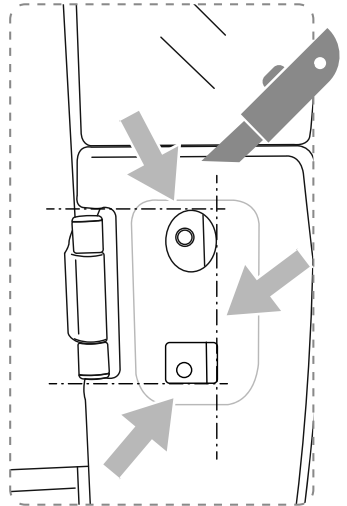
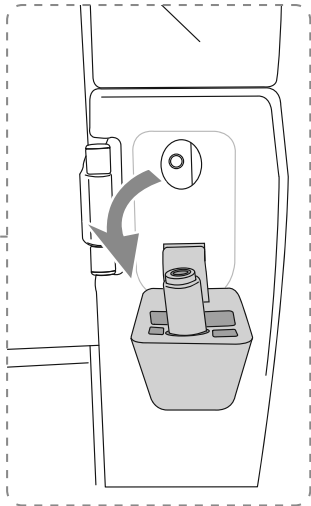
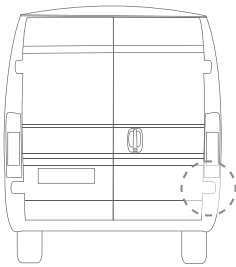

3

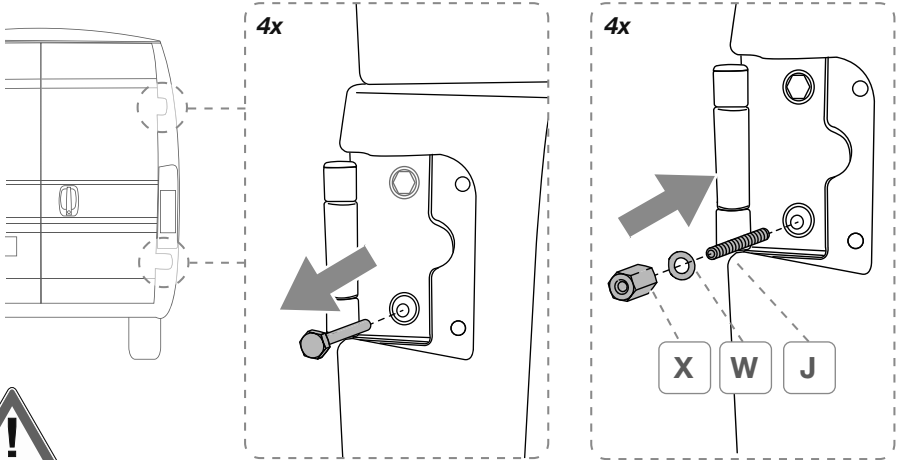

**EN** Remove the first screw and replace with X, W and J. Repeat the operation also with the other screws, but **ALWAYS ONE A TIME**.

**DE** Zuerst die Schraube entfernen und durch X, W und J ersetzen. Den Vorgang auch an den anderen Schrauben wiederholen, aber **IMMER NUR EINZELN**.

**FR** Enlever la première vis et la remplacer par X, W et J. Répéter l'opération pour les autres vis, mais **TOUJOURS L'UNE APRES L'AUTRE**.

**ES** Quite el primer tornillo y sustitúyalo por X, W y J. Repita la operación con los demás tornillos, pero **SIEMPRE DE UNO EN UNO**.

**IT** Rimuovere la prima vite e sostituirla con X, W e J. Ripete l'operazione anche per le altre viti, ma **SEMPRE UNA ALLA VOLTA**.

4

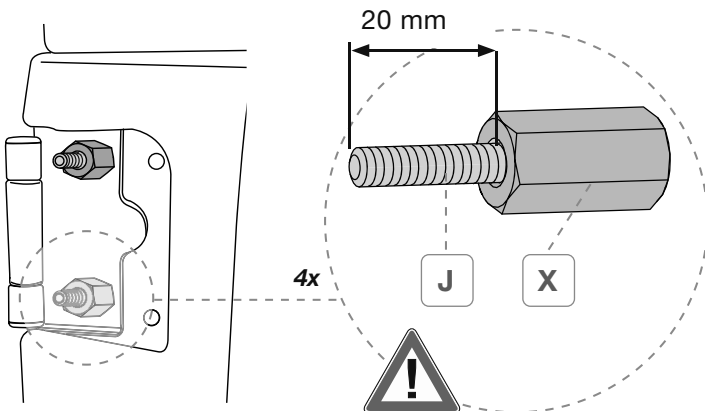



5

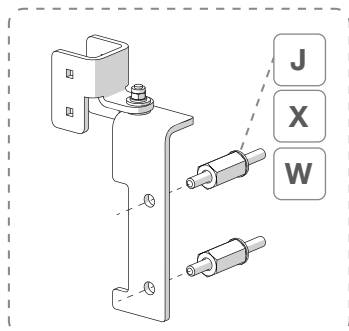
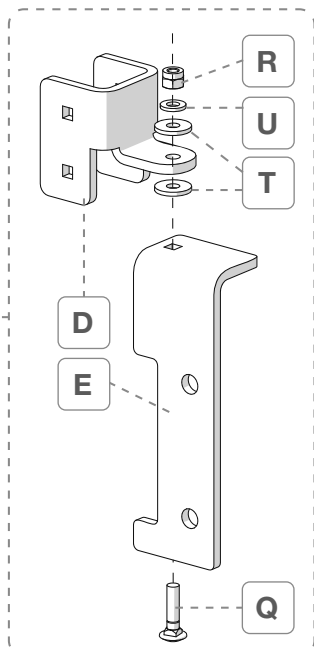
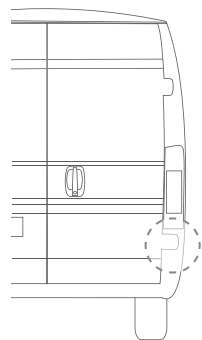

- EN** **Attention:** tighten the screw without forcing
- DE** **Achtung:** schrauben ohne großen Druck anziehen
- FR** **Attention:** serrer la vis sans forcer
- ES** **Cuidado:** apretar el tornillo sin forzar
- IT** **Attenzione:** stringere la vite senza forzare

6

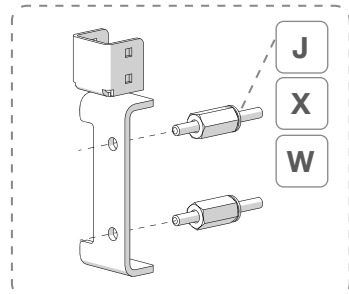
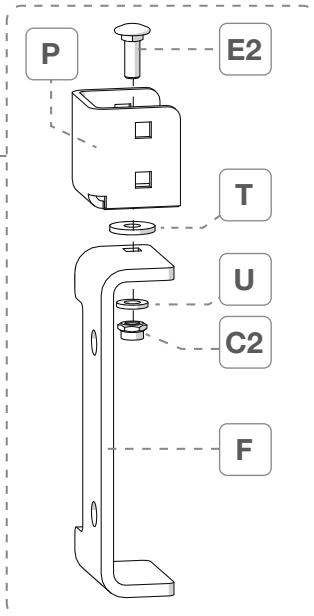
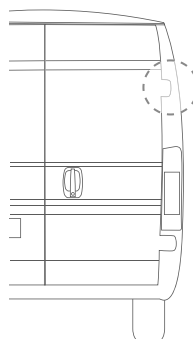

- EN** **Attention:** tighten the screw without forcing
- DE** **Achtung:** Schrauben ohne großen Druck anziehen
- FR** **Attention:** serrer la vis sans forcer
- ES** **Cuidado:** apretar el tornillo sin forzar
- IT** **Attenzione:** stringere la vite senza forzare

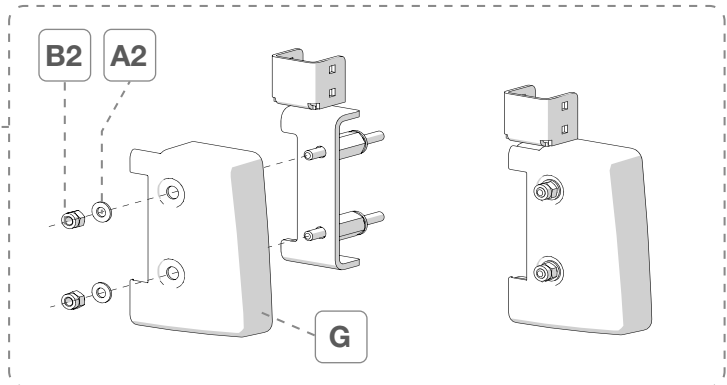
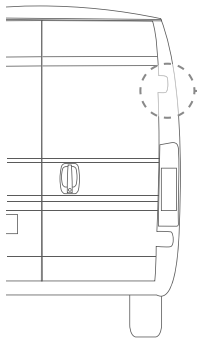
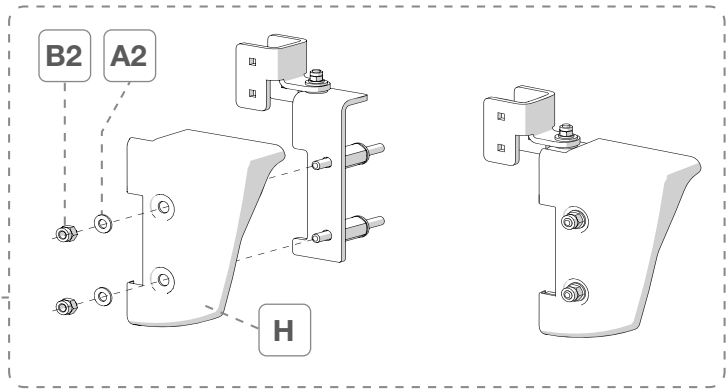
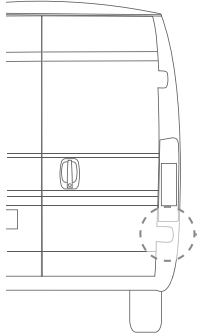

**7****EN**

Do not completely tighten the screws

**ES**

No apretar los tornillos completamente

**DE**

Schrauben bitte nicht komplett anziehen

**IT**

Non stringere completamente le viti

**FR**

Ne pas serrer complètement les vis



8

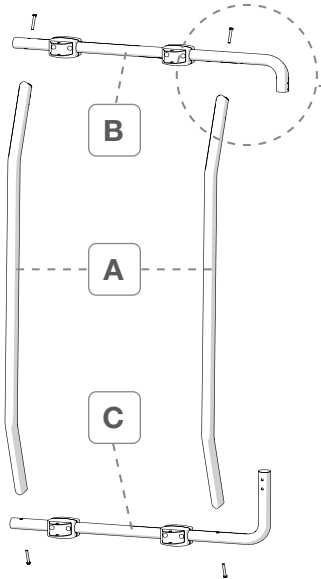

4x

L2

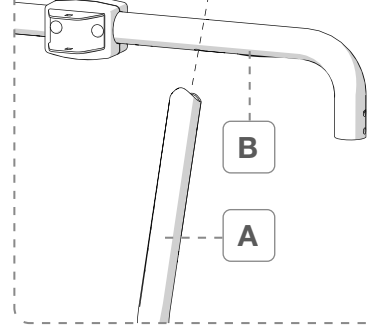

9

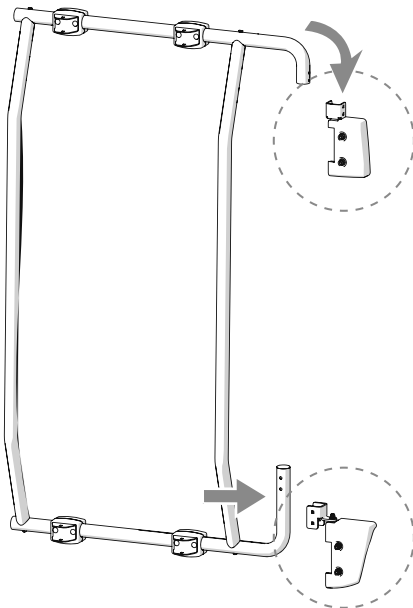

S 2x

G2 2x

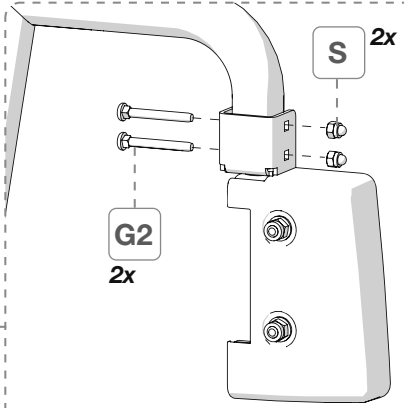

H2 2x

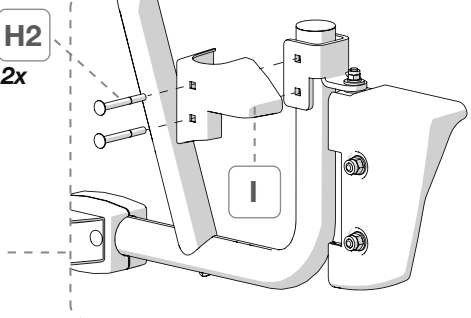



8

9

EN

Tighten the screws firmly

ES

Apretar bien los tornillos

DE

Schrauben bitte gut anziehen

IT

Stringere bene le viti

FR

Bien serrer les vis

10

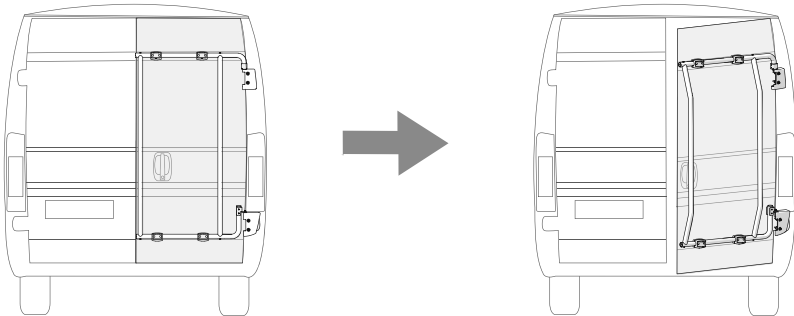

11

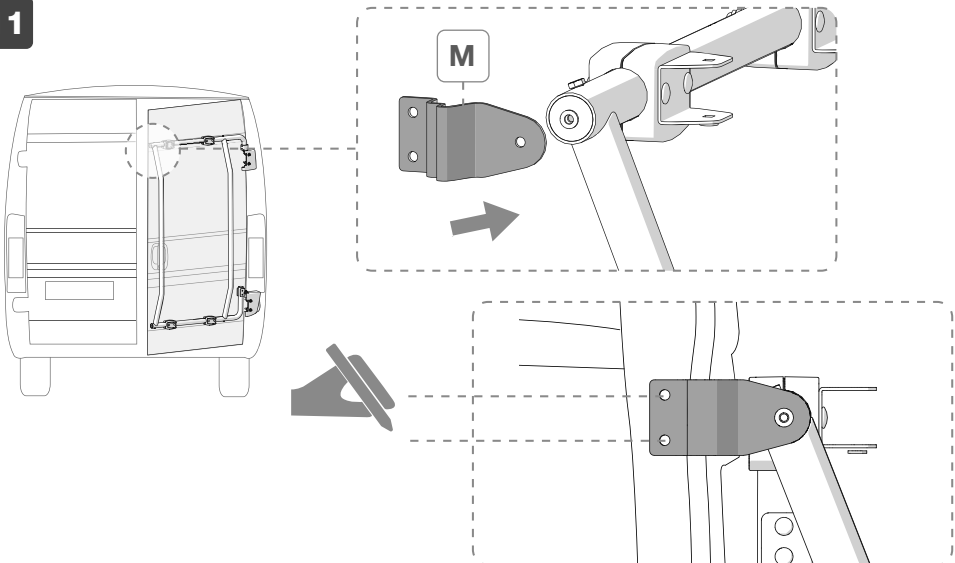



12

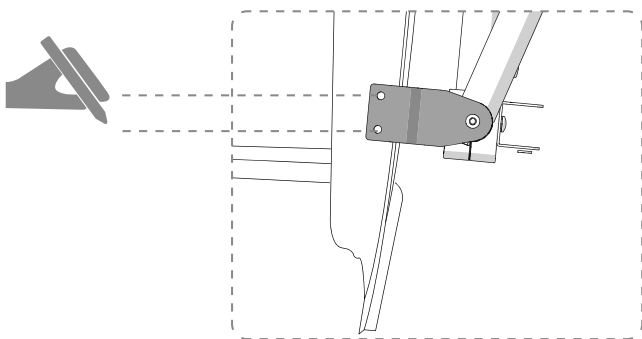
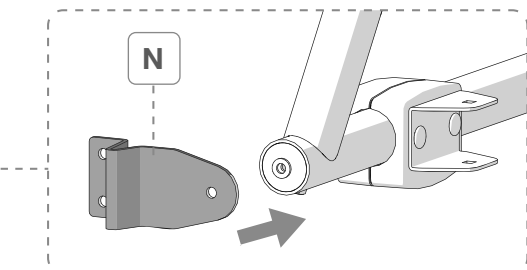
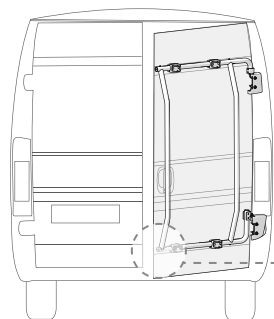

13

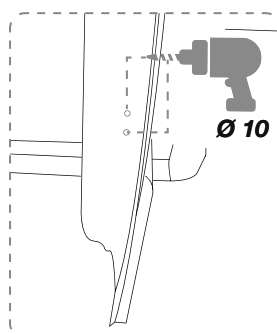
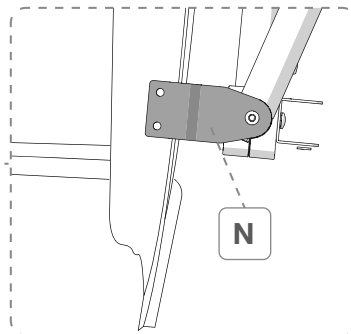
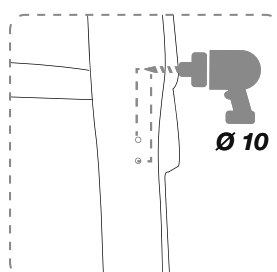
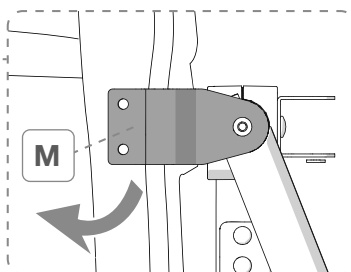
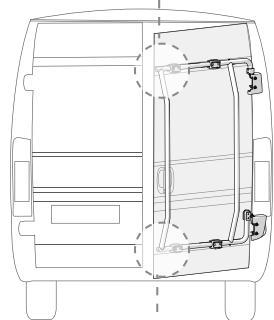

14

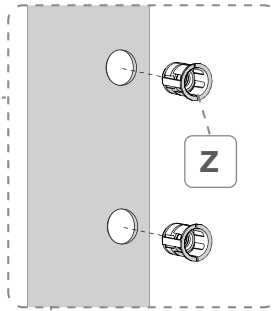
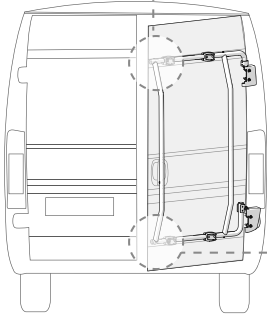

15

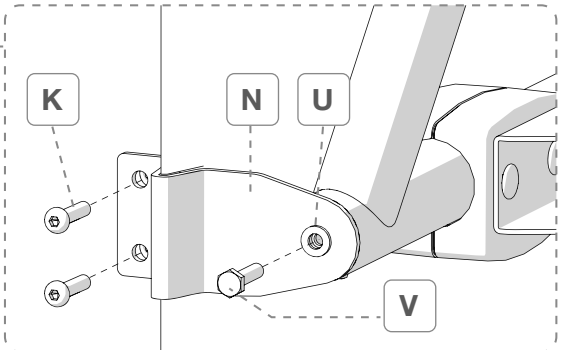
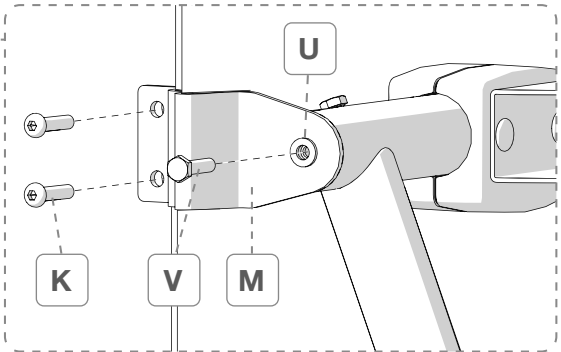
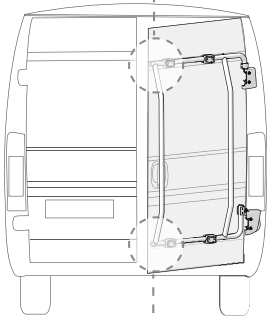



16

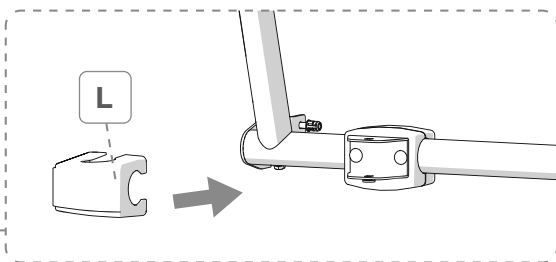
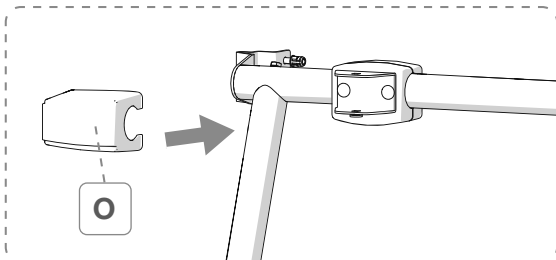
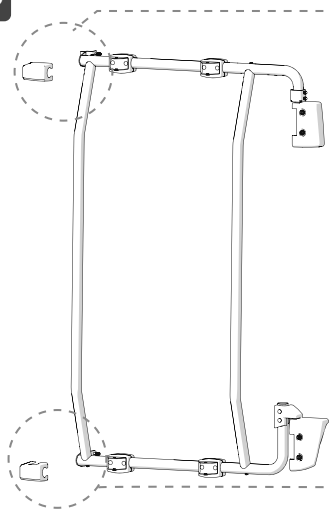

17

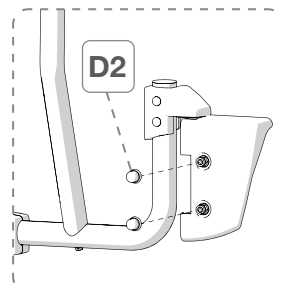
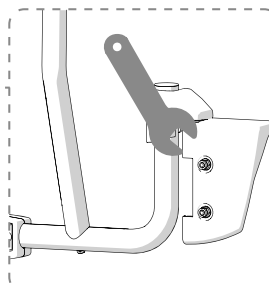
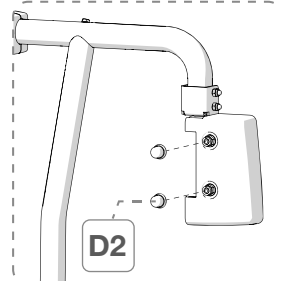
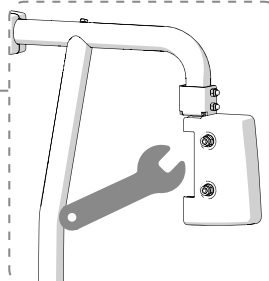
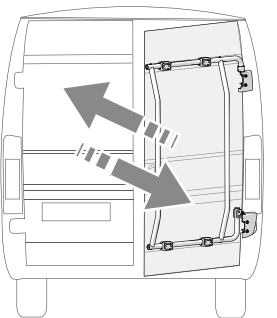
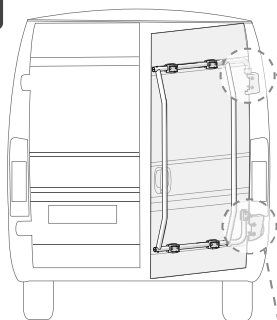





- EN** Attention: keep the following labels and affix them to the Carry-Bike rails.
- DE** Achtung: Bewahren Sie die folgenden Etiketten auf und bringen Sie diese an den Carry-Bike-Schienen an.
- FR** Attention : conserver les étiquettes suivantes ou collez-les sur les rails du Carry-Bike.
- ES** Atención: guardar las siguientes etiquetas o pegarlas en las guías del Carry-Bike.
- IT** Attenzione: conservare le seguenti etichette e applicarle sulle canaline del Carry-Bike.

## CARRY-BIKE®

Alphanumeric Code

Made in Italy



**DE** FAHRRÄDER IMMER FESTBINDEN

**EN** ALWAYS SECURE THE BIKES

**FR** ATTACHEZ TOUJOURS LES VELOS

**ES** FIJAR SIEMPRE LAS BICICLETAS

**IT** FISSARE SEMPRE LE BICICLETTE

FIAMMA S.p.A. - Italy  
Via S. Rocco, 66 - 21010  
Candiano al Campo (VA)

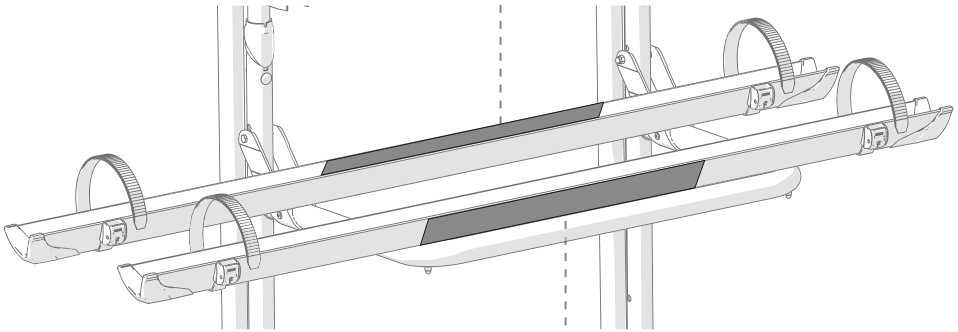

# CARRY-BIKE®

PRODUCT NAME







MAX. LOAD

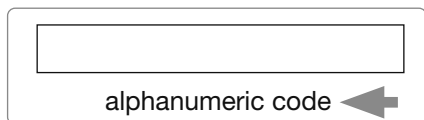

MAX BIKES

Item No.



**EN** In case of problems please contact your local dealer indicating the data on the nameplate. Consult our website for spare parts drawing.

**DE** Bei Problemen bitte den Händler kontaktieren und die auf dem Etikett aufgeführten Daten mitteilen. Auf der Homepage finden Sie die Explosionszeichnung

**FR** En cas de problème, contacter le revendeur et lui communiquer les informations reportées sur la plaquette. Consulter le site Internet pour une vue éclatée des pièces de rechange.

**ES** En caso de cualquier problema, ponerse en contacto con su distribuidor local facilitando los datos sobre la placa. Consultar el sitio web para el despiece de los repuestos.

**IT** In caso di problemi contattare il rivenditore di zona, comunicando i dati riportati sulla targhetta. Consultare il sito web per l'esplosivo ricambi.



**EN** **Warranty Fiamma**  
In case of defects with regards to materials and manufacturing, the customer is entitled to the warranty in accordance with local laws and regulations of the country in which the product was purchased.

**DE** **Garantie Fiamma**  
Im Falle einer Mangelhaftigkeit der Ware, kann der Verbraucher unter den erforderlichen Voraussetzungen gegenüber dem Verkäufer von dem Garantieanspruch zu den festgelegten Bedingungen gemäss den lokalen Rechtsvorschriften Gebrauch machen.

**FR** **Garantie Fiamma**  
En cas d'un défaut de conformité du produit, le consommateur pourra faire valoir ses droits de recours en garantie selon les modalités prévues par les dispositions légales locales, pour autant que les conditions de recours soient satisfaites.

**ES** **Garantía Fiamma**  
En caso de fallos o defectos de material y de fabricación, el cliente puede hacer valer la garantía de acuerdo con las leyes y reglamentaciones del país en el que el producto haya sido comprado.

**IT** **Garanzia Fiamma**  
In caso di difetto di conformità dei beni, il consumatore potrà far valere nei confronti del venditore la garanzia secondo le modalità previste dalle disposizioni di legge locali, ove ne ricorrano i presupposti.











---

---

---

---

---

---

---

---

---

---

---

---

---

---

---

---

---

---

---

---

---

---

---

---

---

---



MO\_IS\_98690M093\_revA



[fiamma.com](http://fiamma.com)

**Fiamma S.p.A. - Italy**

Via San Rocco, 56  
21010 Cardano al Campo (VA)

All rights reserved.

**Fiamma S.p.A.**

reserves the right to modify at any time,  
without notice, prices, materials,  
specifications and models or to cease  
production of any model.